

Smart Motor Controllers

SMC Dialog Plus™ Smart Motor Controller

Starting and Stopping Options

The following options are available in the SMC Dialog Plus controller:

- Soft Stop
- Pump Control
- Preset Slow Speed
- SMB Smart Motor Braking
- Accu-Stop/Slow Speed with Braking

Modes of Operation

The SMC Dialog Plus controller provides the following modes of operation: Soft Start with selectable Kickstart, Current Limit Start, Dual Ramp Start, and Full Voltage Start.

Soft Start

This method has the most general application. The motor is raised to an initial torque value which is programmable from 0 to 90% of locked rotor torque. The motor voltage is gradually increased during the acceleration ramp time, which can be programmed from 0 to 30 seconds.

Features

- Motor Protection
- Metering
- SCANport Communication
- LCD Display
- Keypad Programming
- Three Programmable Auxiliary Contacts

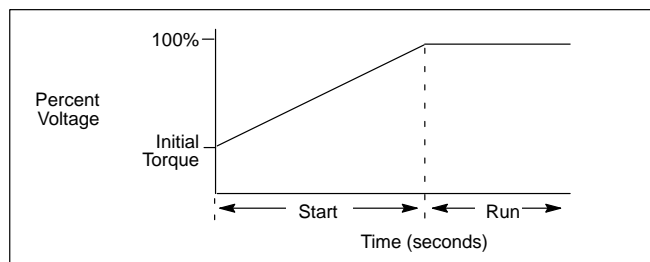

Soft Start with Selectable Kickstart

A kickstart, or boost, at the beginning of the voltage ramp is intended to provide a current pulse of 550% of full load current. The kickstart time is adjustable from 0.0 to 2.0 seconds. This allows the motor to develop additional torque at start for loads which may need a boost to get started.

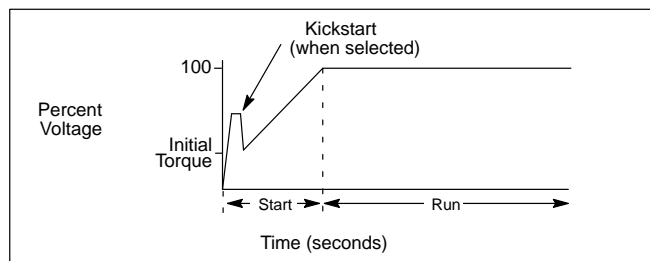

Current Limit Start

This starting mode is used when it is necessary to limit the maximum starting current. The current limit can be programmed for 50 to 600% of full load current.

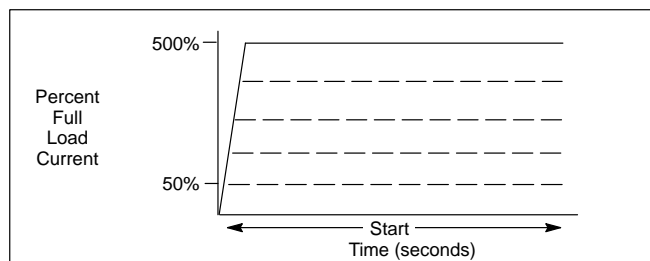

Dual Ramp Start

This starting mode is useful on applications that have varying loads and therefore varying starting torque requirements. The Dual Ramp Start offers the user the option to select between two separate Soft Start profiles with separately adjustable ramp times and initial torque settings.

The acceleration ramp times can be programmed from 0 to 30 seconds. The initial torque values can be programmed from 0 to 90% of locked rotor torque.

Note: Dual Ramp is only available with the standard controller.

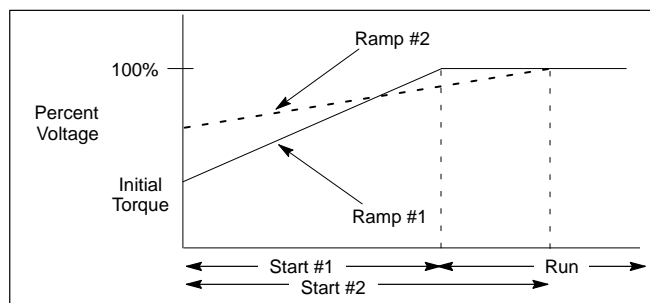

Modes of Operation, Continued

Full Voltage Start

This mode is used for applications requiring across-the-line starting. The ramp time is less than 1/4 second.

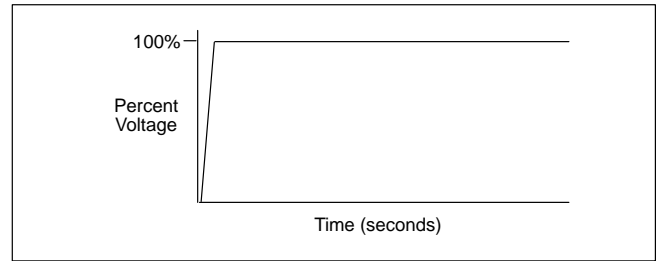

Description of Starting and Stopping Options

The following options are available in the SMC Dialog Plus controller. Only one option may be added to the standard unit.

Soft Stop ●

This option can be used on applications that require an extended coast to rest. It is designed for frictional loads that tend to stop suddenly when voltage is removed from the motor.

The voltage ramp down time can be programmed from 0 to 60 seconds. The load will stop when the motor voltage drops to a point where the load torque is greater than the motor torque.

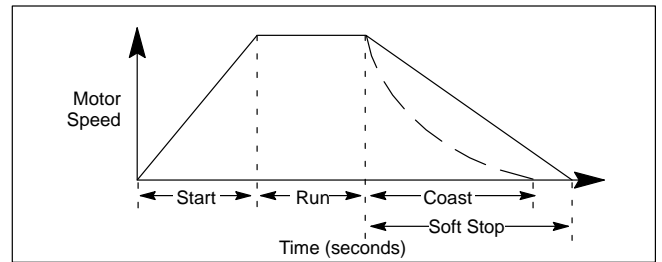

Pump Control ●

This option is used to reduce surges during the starting and stopping of a centrifugal pump by smoothly accelerating and decelerating the motor. The microprocessor analyzes the motor variables and generates commands which control the motor and reduce the possibility of surges occurring in the system.

The starting time is programmable from 0 to 30 seconds and the stopping time is programmable from 0 to 120 seconds.

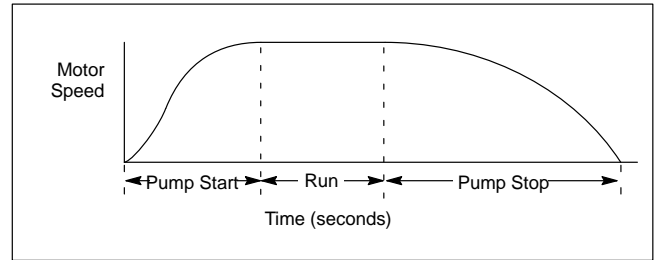

Preset Slow Speed

This option can be used on applications that require a slow speed (for example, moving material into position).

The preset slow speed can be programmed for either 7% of base speed (low) or 15% of base speed (high) in the forward direction. It can also be set for 10% of base speed (low) or 20% of base speed (high) in the reverse direction without a reversing contactor. The direction of rotation is programmable.

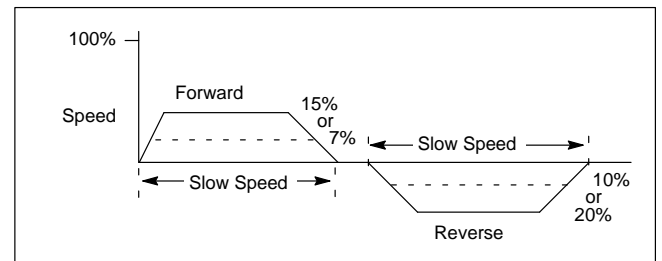

SMB Smart Motor Braking ●

This option provides motor braking for applications that require the motor to stop faster than a coast to rest. Braking control, with automatic zero speed shut off, is fully integrated into the compact design of the SMC Dialog Plus controller. This design facilitates a clean, straightforward installation and eliminates the requirement for additional hardware such as braking contactors, resistors, timers, and speed sensors.

The microprocessor based braking system applies braking current to a standard squirrel cage induction motor. The strength of the braking current is programmable from 150% to 400% of full load current.

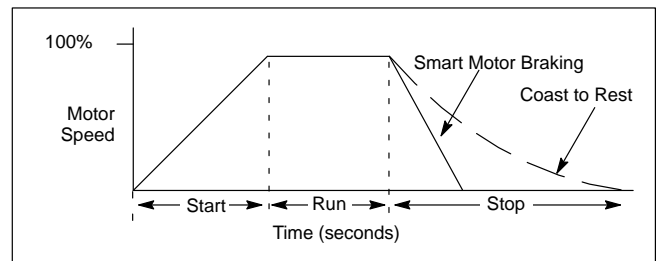

● Not intended to be used as an emergency stop. Refer to the applicable standards for emergency stop requirements.

Smart Motor Controllers

SMC Dialog Plus™ Smart Motor Controller

Description of Options, Continued

Accu-Stop ❶

This option is used in applications requiring controlled position stopping. During stopping, braking torque is applied to the motor until it reaches preset slow speed (7 or 15% of rated speed) and holds the motor at this speed until a stop command is given. Braking torque is then applied until the motor reaches zero speed.

Braking current is programmable from 0 to 400% of full load current. Slow Speed Current is programmable from 0 to 450% of full load current. Slow speed can be programmed for either 7% (low) or 15% (high).

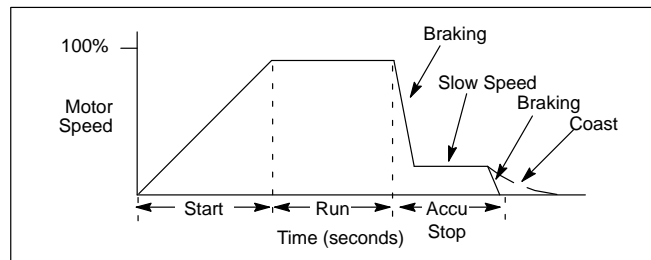

Accu-Stop with Slow Speed at Start ❶

The Accu-Stop option can also allow the motor to operate at a preset slow speed when Slow Speed Start is selected. This minimizes the jogging required to position a load. The start command will ramp the voltage from the preset slow speed to full speed. The operation of Accu-Stop is the same as explained previously.

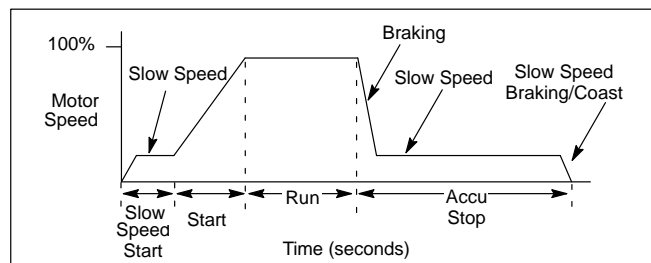

Slow Speed with Braking ❶

Slow Speed with Braking is used on applications that require slow speed (in the forward direction) for positioning or alignment and also require braking control to stop.

Slow speed adjustments are 7% (low) or 15% (high) of rated speed. Slow speed acceleration current is adjustable from 0 to 450%. Slow speed running current is adjustable from 0 to 450% of full load current. Braking current is adjustable from 0 to 400%.

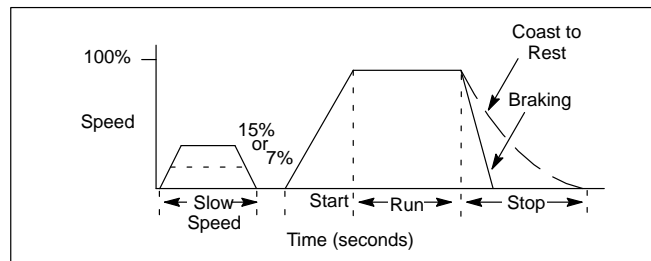

❶ Not intended to be used as an emergency stop. Refer to the applicable standards for emergency stop requirements.

Description of Features

Electronic Motor Overload Protection

The SMC Dialog Plus controller incorporates, as standard, electronic motor overload protection. This overload protection is accomplished electronically with an I²t algorithm.

When coordinated with the proper short circuit protection, overload protection is intended to protect the motor, motor controller, and power wiring against overheating caused by excessive overcurrent. The SMC Dialog Plus controller meets applicable requirements as a motor overload protective device.

The controller's overload protection is programmable, providing the user with flexibility. The overload trip class can be selected for class 10, 15, 20, or 30 protection. The trip current is programmed by entering the motor full load current rating.

Thermal memory is included to accurately model motor operating temperature. Ambient insensitivity is inherent in the electronic design of the overload.

Note: The current sensing capability of the SMC Dialog Plus controller is disabled during bypass operation. The Bulletin 825 Converter Module is required for providing current feedback in these applications.

Stall Protection and Jam Detection

Motors can experience locked rotor currents and develop high torque levels in the event of a stall or a jam. These conditions can result in winding insulation breakdown or mechanical damage to the connected load.

The SMC Dialog Plus controller provides both stall protection and jam detection for enhanced motor and system protection. Stall protection allows the user to program a maximum stall protection delay time from 0 to 10 seconds. The stall protection delay time is in addition to the programmed start time and begins only after the start time has timed out. If the controller senses that the motor is stalled, it will shut down after the delay period has expired.

Jam detection allows the user to determine the motor jam detection level as a percentage of the motor's full load current rating. To prevent nuisance tripping, a jam detection delay time, from 0.0 to 10.0 seconds, can be programmed. This allows the user to select the time delay required before the SMC Dialog Plus controller will trip on a motor jam condition. The motor current must remain above the jam detection level during the delay time. Jam detection is active only after the motor has reached full speed.

Energy Saver

This is a standard feature with the SMC Dialog Plus controller. It is used to save energy on applications where the motor is lightly loaded or unloaded for long periods of time. The Energy Saver is a built-in feature of the controller. **It does not require additional panel space or external wiring.** And, it does not require a complicated setup procedure.

Phase Rebalance

The SMC Dialog Plus controller incorporates, as standard, a dynamic Phase Rebalance feature. The controller

compensates for voltage unbalance by automatically adjusting the voltage output to balance the three-phase currents drawn by the motor. When phase rebalance is achieved, motor life may be extended and production can continue without interruption. Phase Rebalance is a built-in feature of the controller and does not require a complicated set-up procedure.

Note: Phase Rebalance requires the use of the Bulletin 825 converter module and the 150-NFS fanning strip.

Note: The performance of the Phase Rebalance feature is dependent on the motor's loading and characteristics. Severe imbalances cannot be corrected.

Underload Protection

Utilizing the underload protection of the SMC Dialog Plus controller, motor operation can be halted if a sudden drop in current is sensed.

The SMC Dialog Plus controller provides an adjustable underload trip setting from 0 to 99% of the programmed motor full load current rating with an adjustable trip delay time of 0 to 99 seconds.

Undervoltage Protection

The SMC Dialog Plus controller's undervoltage protection will halt motor operation if a sudden drop in the incoming line voltage is detected.

The undervoltage trip level is adjustable as a percentage of the programmed line voltage, from 0 to 99%. To eliminate nuisance trips, a programmable undervoltage trip delay time of 0 to 99 seconds can also be programmed. The line voltage must remain below the undervoltage trip level during the programmed delay time.

Overvoltage Protection

If a sudden rise in the incoming line voltage is detected, the SMC Dialog Plus controller's overvoltage protection will halt motor operation

The overvoltage trip level is adjustable as a percentage of the programmed line voltage, from 0 to 99%. To eliminate nuisance trips, a programmable overvoltage trip delay time of 0 to 99 seconds can also be programmed. The line voltage must remain above the overvoltage trip level during the programmed delay time.

Voltage Unbalance Protection

Voltage unbalance is detected by monitoring the three-phase supply voltage magnitudes in conjunction with the rotational relationship of the three phases. The controller will halt motor operation when the calculated voltage unbalance reaches the user-programmed trip level.

The voltage unbalance trip level is programmable from 0 to 25% unbalance.

Excessive Starts Per Hour

The SMC Dialog Plus controller allows the user to program the allowed number of starts per hour (up to 99). This helps eliminate motor stress caused by repeated starting during a short time period.

Smart Motor Controllers

SMC Dialog Plus™ Smart Motor Controller

Description of Features, Continued

Metering

Power monitoring parameters include:

- Three-phase current
- Three-phase voltage
- Power in kW
- Power usage in kWh
- Power factor
- Motor thermal capacity usage
- Elapsed time

Note: The motor thermal capacity usage allows the user to monitor the amount of overload thermal capacity usage before the SMC Dialog Plus controller's built-in electronic overload trips.

Note: In bypass configurations, the current sensing and power factor measurement capability of the SMC Dialog Plus controller is disabled. Three-phase current measurement, kW, kWh, and motor thermal capacity usage can still be maintained with the use of the Bulletin 825 Converter Module.

Built-in SCANport Communication

A serial interface port is provided as standard, which allows connection to a Bulletin 1201 Human Interface Module or a variety of Bulletin 1203 Communication Modules. This includes Allen-Bradley Remote I/O, DeviceNet network, and RS 232/422/485-DF1.

LCD Display

The SMC Dialog Plus controller's two-line 16-character backlit LCD display provides parameter identification using clear, informative text. Controller set up can be performed quickly and easily without the use of a reference manual. Parameters are arranged in an organized four-level menu structure for ease of programming and fast access to parameters.

Keypad Programming

Programming of parameters is accomplished through a five-button keypad on the front of the SMC Dialog Plus controller. The five buttons include up and down arrows, an Enter button, a Select button, and an Escape button. The user needs only to enter the correct sequence of keystrokes for programming the SMC Dialog Plus controller.

Auxiliary Contacts

Three hard contacts are furnished as standard with the SMC Dialog Plus controller. The first two contacts are programmable for Normal/Up-to-speed. The third is programmable for Normal/Fault.

Easy Ship Program

Select enclosed controllers are available with the following quick deliveries:

- NEMA Type 1 and Type 12 non-combination controllers rated 97 to 360 Amp, 208 to 480V AC, ship in 48 hours.
- NEMA Type 12 circuit breaker combination controllers rated 75 to 300 HP at 480V ship in 4 working days.

Catalog numbers listed in blue type are available on the Easy Ship Program.

Catalog Number Identification

Open and Non-Combination

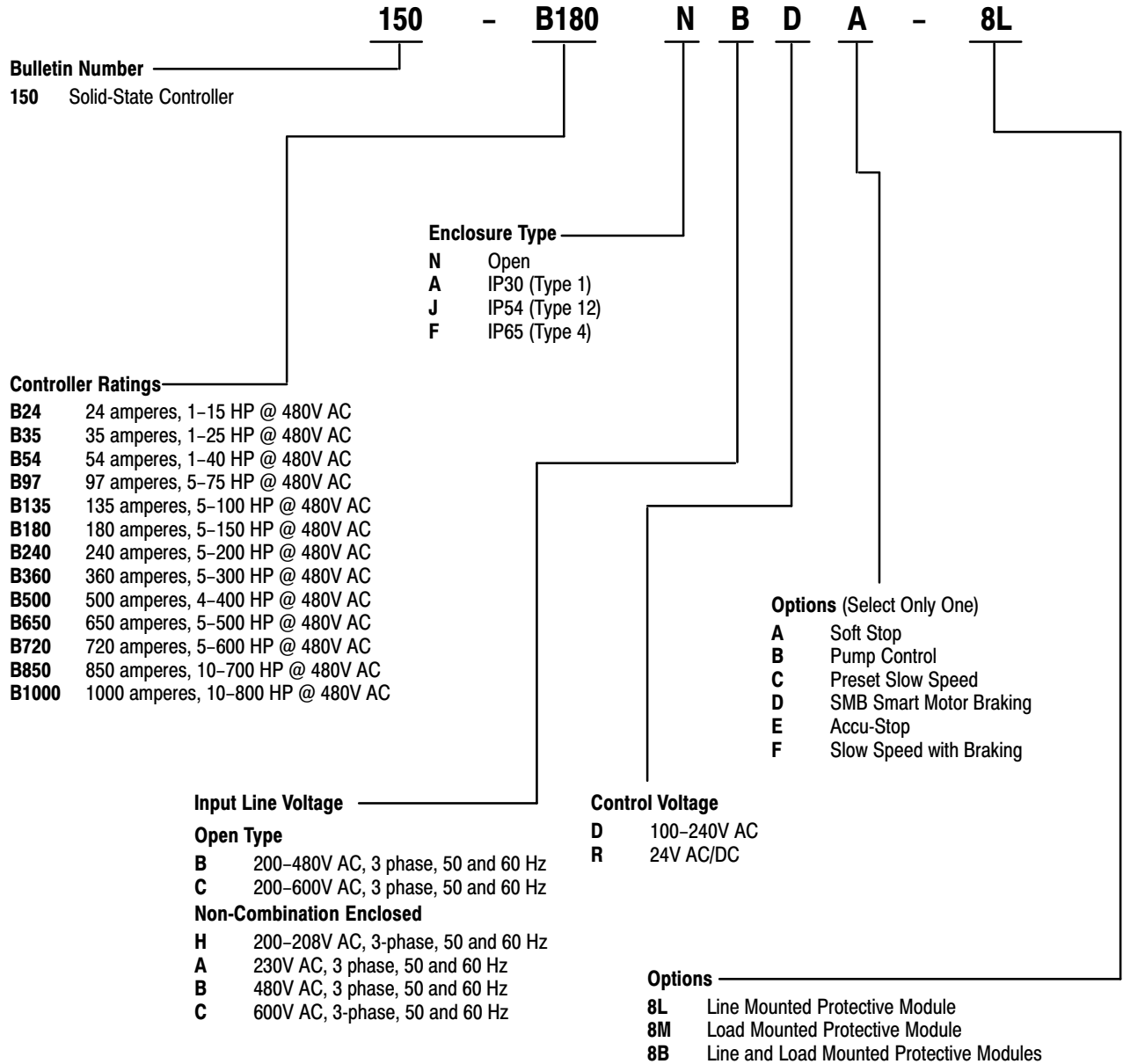

Smart Motor Controllers

SMC Dialog Plus™ Smart Motor Controller

Catalog Number Identification, Continued

Combination

152H - **B240** **A** **BD** **B** - **52** - **8B**

Controller Ratings

B24	24 amperes, 1–15 HP @ 480V AC
B35	35 amperes, 1–25 HP @ 480V AC
B54	54 amperes, 1–40 HP @ 480V AC
B97	97 amperes, 5–75 HP @ 480V AC
B135	135 amperes, 5–100 HP @ 480V AC
B180	180 amperes, 5–150 HP @ 480V AC
B240	240 amperes, 5–200 HP @ 480V AC
B360	360 amperes, 5–300 HP @ 480V AC
B500	500 amperes, 4–400 HP @ 480V AC
B650	650 amperes, 5–500 HP @ 480V AC
B720	720 amperes, 5–600 HP @ 480V AC
B850	850 amperes, 10–700 HP @ 480V AC
B1000	1000 amperes, 10–800 HP @ 480V AC

Enclosure Type

A	IP30 (Type 1)
J	IP54 (Type 12)

Control Options

A	Soft Stop
B	Pump Control
C	Preset Slow Speed
D	SMB Smart Motor Braking
E	Accu-Stop
F	Slow Speed with Braking

Line Voltage

HD	200–208V AC, 3-phase, 50 and 60 Hz
AD	230V AC 3-phase, 50 and 60 Hz
BD	400–480V AC, 3-phase, 50 and 60 Hz
CD	500–600V AC, 3-phase, 50 and 60 Hz

Bulletin Number

152B	Solid-State Controller with Fusible Disconnect and Isolating Contactor
152H	Solid-State Controller with Fusible Disconnect
153B	Solid-State Controller with Circuit Breaker and Isolating Contactor
153H	Solid-State Controller with Circuit Breaker

Horsepower

Cat. No.	HP Rating	Cat. No.	HP Rating	Cat. No.	HP Rating	Cat. No.	HP Rating	Cat. No.	HP Rating
39	5	44	25	49	75	56	250	61	500
40	7.5	45	30	50	100	57	300	62	600
41	10	46	40	51	125	58	350	63	700
42	15	47	50	52	150	59	400	65	800
43	20	48	60	54	200	60	450	67	1000

Options

8L	Line Mounted Protective Module
8M	Load Mounted Protective Module
8B	Line and Load Mounted Protective Modules

Product Selection

Open Type Controllers

Up to 480V AC with 100–240V AC Control Voltage

Current Ⓣ Rating (A)	kW ①		HP ②			Price Adder Code	Cat. No. ④	*	Cat. No. ④	*
	230V AC 50 Hz	400V AC 50 Hz	200V AC 60 Hz	230V AC 60 Hz	460V AC 60 Hz					
24	5.5	11	1–5	1–7.5	1–15	a	150-B24NBD		150-B24NBR	
35	10	18.5	1–10	1–10	1–25	b	150-B35NBD		150-B35NBR	
54	15	22	1–15	1–20	1–40	c	150-B54NBD		150-B54NBR	
97	25	45	5–30	5–30	5–75	d	150-B97NBD		150-B97NBR	
135	37	75	5–40	5–50	5–100	e	150-B135NBD		150-B135NBR	
180	51	90	5–60	5–60	5–150	f	150-B180NBD		150-B180NBR	
240	75	132	5–75	5–75	5–200	g	150-B240NBD		150-B240NBR	
360	110	200	5–125	5–150	5–300	h	150-B360NBD		150-B360NBR	
500	150	257	5–150	5–200	5–400	i	150-B500NBD		150-B500NBR	
650	200	355	5–200	5–250	5–500	j	150-B650NBD		150-B650NBR	
720	220	400	5–250	5–300	5–600	k	150-B720NBD		150-B720NBR	
850	257	475	10–300	10–350	10–700	l	150-B850NBD		150-B850NBR	
1000	315	530	10–350	10–400	10–800	m	150-B1000NBD		150-B1000NBR	

Up to 600V AC with 100–240V AC Control Voltage

Current Ⓣ Rating (A)	kW ①			HP ②				Price Adder Code	Cat. No. ④	*	Cat. No. ④	*
	230V AC 50 Hz	400V AC 50 Hz	500V AC 50 Hz	200V AC 60 Hz	230V AC 60 Hz	460V AC 60 Hz	575V AC 60 Hz					
24	5.5	11	15	1–5	1–7.5	1–15	1–20	a	150-B24NCD		150-B24NCR	
35	10	18.5	22	1–10	1–10	1–25	1–30	b	150-B35NCD		150-B35NCR	
54	15	22	37	1–15	1–20	1–40	1–50	c	150-B54NCD		150-B54NCR	
97	25	45	63	5–30	5–30	5–75	5–75	d	150-B97NCD		150-B97NCR	
135	37	75	90	5–40	5–50	5–100	5–125	e	150-B135NCD		150-B135NCR	
180	51	90	132	5–60	5–60	5–150	5–150	f	150-B180NCD		150-B180NCR	
240	75	132	160	5–75	5–75	5–200	5–250	g	150-B240NCD		150-B240NCR	
360	110	200	250	5–125	5–150	5–300	5–350	h	150-B360NCD		150-B360NCR	
500	150	257	355	5–150	5–200	5–400	5–500	i	150-B500NCD		150-B500NCR	
650	200	355	475	5–200	5–250	5–500	5–600	j	150-B650NCD		150-B650NCR	
720	220	400	500	5–250	5–300	5–600	5–700	k	150-B720NCD		150-B720NCR	
850	257	475	600	10–300	10–350	10–700	10–800	l	150-B850NCD		150-B850NCR	
1000	315	530	710	10–350	10–400	10–800	10–1000	m	150-B1000NCD		150-B1000NCR	

- ① The minimum rating is: 0.7kW for devices with current ratings of 54A or less; 4kW for devices rated 97A through 720A; 7.5kW for devices rated 850A and greater.
- ② HP ratings at motor terminal voltages for 208, 480 and 600 line volts respectively.
- ③ Controllers rated 97A and greater are not equipped with line and load terminal lugs. See page 3-37 for terminal lug kits.
- ④ To order a controller that accepts 24V AC/DC control power input, replace the letter D with R in the catalog number.
Example: Cat. No. 150-B135NBD becomes Cat. No. 150-B135NBR.

Options — Page 3-59
 Accessories — Page 3-62
 Specifications — Page 3-65
 Dimensions — Page 3-68

Smart Motor Controllers

SMC Dialog Plus™ Smart Motor Controller

Product Selection, Continued

IP30 (Type 1) Vented Enclosed Non-Combination Controllers – requires a separate 100–240V, 50/60 Hz single-phase control source. Line and load terminations are provided as standard. Enclosures other than those listed are available; consult your nearest Allen-Bradley sales office.

Current Rating (A)	HP	Price Adder Code	Cat. No.	*	Current Rating (A)	kW ①	HP	Price Adder Code	Cat. No.	*
	200V AC 60 Hz					230V AC 50 Hz	230V AC 60 Hz			
208V AC					240V AC					
24	1–5	a	150-B24AHD ②		24	5.5	1–7.5	a	150-B24AAD ②	
35	1–10	b	150-B35AHD ②		35	10	1–10	b	150-B35AAD ②	
54	1–15	c	150-B54AHD ②		54	15	1–20	c	150-B54AAD ②	
97	5–30	d	150-B97AHD		97	25	5–30	d	150-B97AAD	
135	5–40	e	150-B135AHD		135	37	5–50	e	150-B135AAD	
180	5–60	f	150-B180AHD		180	51	5–60	f	150-B180AAD	
240	5–75	g	150-B240AHD		240	75	5–75	g	150-B240AAD	
360	5–125	h	150-B360AHD		360	110	5–150	h	150-B360AAD	
500	5–150	i	150-B500AHD		500	150	5–200	i	150-B500AAD	
650	5–200	j	150-B650AHD		650	200	5–250	j	150-B650AAD	
720	5–250	k	150-B720AHD		720	220	5–300	k	150-B720AAD	
850	10–300	l	150-B850AHD		850	257	10–350	l	150-B850AAD	
1000	10–350	m	150-B1000AHD		1000	315	10–400	m	150-B1000AAD	

Current Rating (A)	kW ①	HP	Price Adder Code	Cat. No.	*	Current Rating (A)	kW ①	HP	Price Adder Code	Cat. No.	*
	400V AC 50 Hz	460V AC 60 Hz					500V AC 50 Hz	575V AC 60 Hz			
480V AC						600V AC					
24	11	1–15	a	150-B24ABD ②		24	15	1–20	a	150-B24ACD ②	
35	18.5	1–25	b	150-B35ABD ②		35	22	1–30	b	150-B35ACD ②	
54	22	1–40	c	150-B54ABD ②		54	37	1–50	c	150-B54ACD ②	
97	45	5–75	d	150-B97ABD		97	63	5–75	d	150-B97ACD	
135	75	5–100	e	150-B135ABD		135	90	5–125	e	150-B135ACD	
180	90	5–150	f	150-B180ABD		180	132	5–150	f	150-B180ACD	
240	132	5–200	g	150-B240ABD		240	160	5–250	g	150-B240ACD	
360	200	5–300	h	150-B360ABD		360	250	5–350	h	150-B360ACD	
500	257	5–400	i	150-B500ABD		500	355	5–500	i	150-B500ACD	
650	355	5–500	j	150-B650ABD		650	475	5–600	j	150-B650ACD	
720	400	5–600	k	150-B720ABD		720	500	5–700	k	150-B720ACD	
850	475	10–700	l	150-B850ABD		850	600	10–800	l	150-B850ACD	
1000	530	10–800	m	150-B1000ABD		1000	710	10–1000	m	150-B1000ACD	

① The minimum rating is 0.7kW for devices with current ratings of 54A or less; 4kW for devices rated 97A through 720A; 7.5kW for devices 850A and greater.

② Includes internal circulating fan rather than enclosure ventilation.

Options — Page [3-59](#)
 Accessories — Page [3-62](#)
 Specifications — Page [3-65](#)
 Dimensions — Page [3-68](#)

Product Selection, Continued

IP65 (Type 4) Enclosed Non-Combination Controllers – require a separate 100–240V, 50/60 Hz single-phase control source. Line and load terminations are provided as standard. The 97 to 1000A controllers include a bypass contactor and a Bulletin 825 converter module. Enclosures other than those listed are available; consult your nearest Allen-Bradley sales office.

Current Rating (A)	HP		Price Adder Code	Cat. No.	*	Current Rating (A)	kW ①		HP		Price Adder Code	Cat. No.	*
	200V AC 60 Hz						230V AC 50 Hz	230V AC 60 Hz					
208V AC						240V AC							
24	1-5	a		150-B24FHD		24	5.5	1-7.5	a		150-B24FAD		
35	1-10	b		150-B35FHD		35	10	1-10	b		150-B35FAD		
54	1-15	c		150-B54FHD		54	15	1-20	c		150-B54FAD		
97	5-30	d		150-B97FHD		97	25	5-30	d		150-B97FAD		
135	5-40	e		150-B135FHD		135	37	5-50	e		150-B135FAD		
180	5-60	f		150-B180FHD		180	51	5-60	f		150-B180FAD		
240	5-75	g		150-B240FHD		240	75	5-75	g		150-B240FAD		
360	5-125	h		150-B360FHD		360	110	5-150	h		150-B360FAD		
500	5-150	i		150-B500FHD		500	150	5-200	i		150-B500FAD		
650	5-200	j		150-B650FHD		650	200	5-250	j		150-B650FAD		
720	5-250	k		150-B720FHD		720	220	5-300	k		150-B720FAD		
850	10-300	l		150-B850FHD		850	257	10-350	l		150-B850FAD		
1000	10-350	m		150-B1000FHD		1000	315	10-400	m		150-B1000FAD		

Current Rating (A)	kW ①		HP		Price Adder Code	Cat. No.	*	Current Rating (A)	kW ①		HP		Price Adder Code	Cat. No.	*
	400V AC 50 Hz	460V AC 60 Hz	500V AC 50 Hz	575V AC 60 Hz											
480V AC							600V AC								
24	11	1-15	a		150-B24FBD		24	15	1-20	a		150-B24FCD			
35	18.5	1-25	b		150-B35FBD		35	22	1-30	b		150-B35FCD			
54	22	1-40	c		150-B54FBD		54	37	1-50	c		150-B54FCD			
97	45	5-75	d		150-B97FBD		97	63	5-75	d		150-B97FCD			
135	75	5-100	e		150-B135FBD		135	90	5-125	e		150-B135FCD			
180	90	5-150	f		150-B180FBD		180	132	5-150	f		150-B180FCD			
240	132	5-200	g		150-B240FBD		240	160	5-250	g		150-B240FCD			
360	200	5-300	h		150-B360FBD		360	250	5-350	h		150-B360FCD			
500	257	5-400	i		150-B500FBD		500	355	5-500	i		150-B500FCD			
650	355	5-500	j		150-B650FBD		650	475	5-600	j		150-B650FCD			
720	400	5-600	k		150-B720FBD		720	500	5-700	k		150-B720FCD			
850	475	10-700	l		150-B850FBD		850	600	10-800	l		150-B850FCD			
1000	530	10-800	m		150-B1000FBD		1000	710	10-1000	m		150-B1000FCD			

① The minimum rating is 0.7kW for devices with current ratings of 54A or less; 4kW for devices rated 97A through 720A; 7.5kW for devices 850A and greater.

Options — Page 3-59
 Accessories — Page 3-62
 Specifications — Page 3-65
 Dimensions — Page 3-68

Smart Motor Controllers

SMC Dialog Plus™ Smart Motor Controller

Product Selection, Continued

IP54 (Type 12) Enclosed Non-Combination Controllers – require a separate 100–240V, 50/60 Hz single-phase control source. Line and load terminations are provided as standard. The 97 to 1000A controllers include a bypass contactor and a Bulletin 825 converter module. Enclosures other than those listed are available; consult your nearest Allen-Bradley sales office.

Current Rating (A)	HP	Price Adder Code	Cat. No.	*	Current Rating (A)	kW ①	HP	Price Adder Code	Cat. No.	*
	200V AC 60 Hz					230V AC 50 Hz	230V AC 60 Hz			
208V AC					240V AC					
24	1-5	a	150-B24JHD		24	5.5	1-7.5	a	150-B24JAD	
35	1-10	b	150-B35JHD		35	10	1-10	b	150-B35JAD	
54	1-15	c	150-B54JHD		54	15	1-20	c	150-B54JAD	
97	5-30	d	150-B97JHD		97	25	5-30	d	150-B97JAD	
135	5-40	e	150-B135JHD		135	37	5-50	e	150-B135JAD	
180	5-60	f	150-B180JHD		180	51	5-60	f	150-B180JAD	
240	5-75	g	150-B240JHD		240	75	5-75	g	150-B240JAD	
360	5-125	h	150-B360JHD		360	110	5-150	h	150-B360JAD	
500	5-150	i	150-B500JHD		500	150	5-200	i	150-B500JAD	
650	5-200	j	150-B650JHD		650	200	5-250	j	150-B650JAD	
720	5-250	k	150-B720JHD		720	220	5-300	k	150-B720JAD	
850	10-300	l	150-B850JHD		850	257	10-350	l	150-B850JAD	
1000	10-350	m	150-B1000JHD		1000	315	10-400	m	150-B1000JAD	

Current Rating (A)	kW ①	HP	Price Adder Code	Cat. No.	*	Current Rating (A)	kW ①	HP	Price Adder Code	Cat. No.	*
	400V AC 50 Hz	460V AC 60 Hz					500V AC 50 Hz	575V AC 60 Hz			
480V AC						600V AC					
24	11	1-15	a	150-B24JBD		24	15	1-20	a	150-B24JCD	
35	18.5	1-25	b	150-B35JBD		35	22	1-30	b	150-B35JCD	
54	22	1-40	c	150-B54JBD		54	37	1-50	c	150-B54JCD	
97	45	5-75	d	150-B97JBD		97	63	5-75	d	150-B97JCD	
135	75	5-100	e	150-B135JBD		135	90	5-125	e	150-B135JCD	
180	90	5-150	f	150-B180JBD		180	132	5-150	f	150-B180JCD	
240	132	5-200	g	150-B240JBD		240	160	5-250	g	150-B240JCD	
360	200	5-300	h	150-B360JBD		360	250	5-350	h	150-B360JCD	
500	257	5-400	i	150-B500JBD		500	355	5-500	i	150-B500JCD	
650	355	5-500	j	150-B650JBD		650	475	5-600	j	150-B650JCD	
720	400	5-600	k	150-B720JBD		720	500	5-700	k	150-B720JCD	
850	475	10-700	l	150-B850JBD		850	600	10-800	l	150-B850JCD	
1000	530	10-800	m	150-B1000JBD		1000	710	10-1000	m	150-B1000JCD	

① The minimum rating is 0.7kW for devices with current ratings of 54A or less; 4kW for devices rated 97A through 720A; 7.5kW for devices 850A and greater.

Options — Page [3-59](#)
 Accessories — Page [3-62](#)
 Specifications — Page [3-65](#)
 Dimensions — Page [3-68](#)

Product Selection, Continued

IP30 (Type 1) Vented Enclosed Combination Controllers with Fusible Disconnect – include a 120V central transformer and line and load terminations. Enclosures other than those listed are available; consult your nearest Allen-Bradley sales office.

HP Range	Controller Current Rating (A) ❶	Price Adder Code	Cat. No. ❸	*	HP Range	Controller Current Rating (A) ❶	Price Adder Code	Cat. No. ❸	*
208V AC, 60 Hz					240V AC, 60 Hz				
1-5	24	a	152H-B24AHD-__ ❷		1-7-1/2	24	a	152H-B24AAD-__ ❷	
7-1/2-10	35	b	152H-B35AHD-__ ❷		10	35	b	152H-B35AAD-__ ❷	
15-20	54	c	152H-B54AHD-__ ❷		15-20	54	c	152H-B54AAD-__ ❷	
25-30	97	d	152H-B97AHD-__		25-30	97	d	152H-B97AAD-__	
40	135	e	152H-B135AHD-__		40-50	135	e	152H-B135AAD-__	
50-60	180	f	152H-B180AHD-__		60	180	f	152H-B180AAD-__	
75	240	g	152H-B240AHD-__		75	240	g	152H-B240AAD-__	
100-125	360	h	152H-B360AHD-__		100-150	360	h	152H-B360AAD-__	
150	500	i	152H-B500AHD-__		200	500	i	152H-B500AAD-__	
200	650	j	152H-B650AHD-__		250	650	j	152H-B650AAD-__	
250	720	k	152H-B720AHD-__		300	720	k	152H-B720AAD-__	
300	850	l	152H-B850AHD-__		350	850	l	152H-B850AAD-__	
350	1000	m	152H-B1000AHD-__		400	1000	m	152H-B1000AAD-__	

HP Range	Controller Current Rating (A) ❶	Price Adder Code	Cat. No. ❸	*	HP Range	Controller Current Rating (A) ❶	Price Adder Code	Cat. No. ❸	*
480V AC, 60 Hz					600V AC, 60 Hz				
1-15	24	a	152H-B24ABD-__ ❷		1-20	24	a	152H-B24ACD-__ ❷	
20-25	35	b	152H-B35ABD-__ ❷		25-30	35	b	152H-B35ACD-__ ❷	
30-40	54	c	152H-B54ABD-__ ❷		40-50	54	c	152H-B54ACD-__ ❷	
50-75	97	d	152H-B97ABD-__		60-75	97	d	152H-B97ACD-__	
100	135	e	152H-B135ABD-__		100-125	135	e	152H-B135ACD-__	
125-150	180	f	152H-B180ABD-__		150	180	f	152H-B180ACD-__	
200	240	g	152H-B240ABD-__		200-250	240	g	152H-B240ACD-__	
250-300	360	h	152H-B360ABD-__		300	360	h	152H-B360ACD-__	
350-400	500	i	152H-B500ABD-__		350-500	500	i	152H-B500ACD-__	
450-500	650	j	152H-B650ABD-__		600	650	j	152H-B650ACD-__	
600	720	k	152H-B720ABD-__		700	720	k	152H-B720ACD-__	
700	850	l	152H-B850ABD-__		800	850	l	152H-B850ACD-__	
800	1000	m	152H-B1000ABD-__		1000	1000	m	152H-B1000ACD-__	

- ❶ The nominal current rating for the combination package may differ from the controller, based on the horsepower. Consult your nearest Allen-Bradley sales office.
- ❷ Includes internal circulating fan rather than enclosure ventilation.
- ❸ The catalog numbers listed are not complete. Select the horsepower suffix from Table 1 to complete the catalog number. Example: To order a fusible disconnect combination controller for a 200 HP motor with 480V line voltage, the catalog number is 152H-B240ABD-54.

Table 1

HP	Suffix	HP	Suffix	HP	Suffix	HP	Suffix	HP	Suffix
1-5	-39	25	-44	75	-49	250	-56	500	-61
7.5	-40	30	-45	100	-50	300	-57	600	-62
10	-41	40	-46	125	-51	350	-58	700	-63
15	-42	50	-47	150	-52	400	-59	800	-65
20	-43	60	-48	200	-54	450	-60	1000	-67

Options — Page 3-59
 Accessories — Page 3-62
 Specifications — Page 3-65
 Dimensions — Page 3-68

Smart Motor Controllers

SMC Dialog Plus™ Smart Motor Controller

Product Selection, Continued

IP54 (Type 12) Enclosed Combination Controllers with Fusible Disconnect – include a 120V control transformer and line and load terminations. The 97 to 1000A controllers include a bypass contactor and a Bulletin 825 converter module. Enclosures other than those listed are available; consult your nearest Allen-Bradley sales office.

HP Range	Controller Current Rating (A) ❶	Price Adder Code	Cat. No. ❷	*	HP Range	Controller Current Rating (A) ❶	Price Adder Code	Cat. No. ❷	*
208V AC, 60 Hz					240V AC, 60 Hz				
1-5	24	a	152H-B24JHD-___ ❸		1-7-1/2	24	a	152H-B24JAD-___ ❸	
7-1/2-10	35	b	152H-B35JHD-___ ❸		10	35	b	152H-B35JAD-___ ❸	
15-20	54	c	152H-B54JHD-___ ❸		15-20	54	c	152H-B54JAD-___ ❸	
25-30	97	d	152H-B97JHD-___		25-30	97	d	152H-B97JAD-___	
40	135	e	152H-B135JHD-___		40-50	135	e	152H-B135JAD-___	
50-60	180	f	152H-B180JHD-___		60	180	f	152H-B180JAD-___	
75	240	g	152H-B240JHD-___		75	240	g	152H-B240JAD-___	
100-125	360	h	152H-B360JHD-___		100-150	360	h	152H-B360JAD-___	
150	500	i	152H-B500JHD-___		200	500	i	152H-B500JAD-___	
200	650	j	152H-B650JHD-___		250	650	j	152H-B650JAD-___	
250	720	k	152H-B720JHD-___		300	720	k	152H-B720JAD-___	
300	850	l	152H-B850JHD-___		350	850	l	152H-B850JAD-___	
350	1000	m	152H-B1000JHD-___		400	1000	m	152H-B1000JAD-___	

HP Range	Controller Current Rating (A) ❶	Price Adder Code	Cat. No. ❷	*	HP Range	Controller Current Rating (A) ❶	Price Adder Code	Cat. No. ❷	*
480V AC, 60 Hz					600V AC, 60 Hz				
1-15	24	a	152H-B24JBD-___ ❸		1-20	24	a	152H-B24JCD-___ ❸	
20-25	35	b	152H-B35JBD-___ ❸		25-30	35	b	152H-B35JCD-___ ❸	
30-40	54	c	152H-B54JBD-___ ❸		40-50	54	c	152H-B54JCD-___ ❸	
50-75	97	d	152H-B97JBD-___		60-75	97	d	152H-B97JCD-___	
100	135	e	152H-B135JBD-___		100-125	135	e	152H-B135JCD-___	
125-150	180	f	152H-B180JBD-___		150	180	f	152H-B180JCD-___	
200	240	g	152H-B240JBD-___		200-250	240	g	152H-B240JCD-___	
250-300	360	h	152H-B360JBD-___		300	360	h	152H-B360JCD-___	
350-400	500	i	152H-B500JBD-___		350-500	500	i	152H-B500JCD-___	
450-500	650	j	152H-B650JBD-___		600	650	j	152H-B600JCD-___	
600	720	k	152H-B720JBD-___		700	720	k	152H-B720JCD-___	
700	850	l	152H-B850JBD-___		800	850	l	152H-B850JCD-___	
800	1000	m	152H-B1000JBD-___		1000	1000	m	152H-B1000JCD-___	

❶ The nominal current rating for the combination package may differ from the controller, based on the horsepower. Consult your nearest Allen-Bradley sales office.

❷ The catalog numbers listed are not complete. Select the horsepower suffix from Table 1 to complete the catalog number. Example: To order a fusible disconnect combination controller for a 200 HP motor with 480V line voltage, the catalog number is 152H-B240JBD-54.

❸ Supplied without bypass contactor or converter module.

Table 1

HP	Suffix	HP	Suffix	HP	Suffix	HP	Suffix	HP	Suffix
1-5	-39	25	-44	75	-49	250	-56	500	-61
7.5	-40	30	-45	100	-50	300	-57	600	-62
10	-41	40	-46	125	-51	350	-58	700	-63
15	-42	50	-47	150	-52	400	-59	800	-65
20	-43	60	-48	200	-54	450	-60	1000	-67

Options — Page 3-59
 Accessories — Page 3-62
 Specifications — Page 3-65
 Dimensions — Page 3-68

Product Selection, Continued

IP30 (Type 1) Vented Enclosed Combination Controllers with Circuit Breaker – include a 120V control transformer and line and load terminations. Enclosures other than those listed are available; consult your nearest Allen-Bradley sales office.

HP Range	Controller Current Rating (A) ❶	Price Adder Code	Cat. No. ❷	*	HP Range	Controller Current Rating (A) ❶	Price Adder Code	Cat. No. ❷	*
208V AC, 60 Hz					240V AC, 60 Hz				
1-5	24	a	153H-B24AHD-__❷		1-7-1/2	24	a	153H-B24AAD-__❷	
7-1/2-10	35	b	153H-B35AHD-__❷		10	35	b	153H-B35AAD-__❷	
15-20	54	c	153H-B54AHD-__❷		15-20	54	c	153H-B54AAD-__❷	
25-30	97	d	153H-B97AHD-__		25-30	97	d	153H-B97AAD-__	
40	135	e	153H-B135AHD-__		40-50	135	e	153H-B135AAD-__	
50-60	180	f	153H-B180AHD-__		60	180	f	153H-B180AAD-__	
75	240	g	153H-B240AHD-__		75	240	g	153H-B240AAD-__	
100-125	360	h	153H-B360AHD-__		100-150	360	h	153H-B360AAD-__	
150	500	i	153H-B500AHD-__		200	500	i	153H-B500AAD-__	
200	650	j	153H-B650AHD-__		250	650	j	153H-B650AAD-__	
250	720	k	153H-B720AHD-__		300	720	k	153H-B720AAD-__	
300	850	l	153H-B850AHD-__		350	850	l	153H-B850AAD-__	
350	1000	m	153H-B1000AHD-__		400	1000	m	153H-B1000AAD-__	

HP Range	Controller Current Rating (A) ❶	Price Adder Code	Cat. No. ❷	*	HP Range	Controller Current Rating (A) ❶	Price Adder Code	Cat. No. ❷	*
480V AC, 60 Hz					600V AC, 60 Hz				
1-15	24	a	153H-B24ABD-__❷		1-20	24	a	153H-B24ACD-__❷	
20-25	35	b	153H-B35ABD-__❷		25-30	35	b	153H-B35ACD-__❷	
30-40	54	c	153H-B54ABD-__❷		40-50	54	c	153H-B54ACD-__❷	
50-75	97	d	153H-B97ABD-__		60-75	97	d	153H-B97ACD-__	
100	135	e	153H-B135ABD-__		100-125	135	e	153H-B135ACD-__	
125-150	180	f	153H-B180ABD-__		150	180	f	153H-B180ACD-__	
200	240	g	153H-B240ABD-__		200-250	240	g	153H-B240ACD-__	
250-300	360	h	153H-B360ABD-__		300	360	h	153H-B360ACD-__	
350-400	500	i	153H-B500ABD-__		350-500	500	i	153H-B500ACD-__	
450-500	650	j	153H-B650ABD-__		600	650	j	153H-B650ACD-__	
600	720	k	153H-B720ABD-__		700	720	k	153H-B720ACD-__	
700	850	l	153H-B850ABD-__		800	850	l	153H-B850ACD-__	
800	1000	m	153H-B1000ABD-__		1000	1000	m	153H-B1000ACD-__	

- ❶ The nominal current rating for the combination package may differ from the controller, based on the horsepower. Consult your nearest Allen-Bradley sales office.
- ❷ Includes internal circulating fan rather than enclosure ventilation.
- ❸ The catalog numbers listed are not complete. Select the horsepower suffix from Table 1 to complete the catalog number. Example: To order a circuit breaker style combination controller for a 200 HP motor with 480V line voltage, the catalog number is 153H-B240ABD-54.

Table 1

HP	Suffix	HP	Suffix	HP	Suffix	HP	Suffix	HP	Suffix
1-5	-39	25	-44	75	-49	250	-56	500	-61
7.5	-40	30	-45	100	-50	300	-57	600	-62
10	-41	40	-46	125	-51	350	-58	700	-63
15	-42	50	-47	150	-52	400	-59	800	-65
20	-43	60	-48	200	-54	450	-60	1000	-67

Options — Page 3-59
 Accessories — Page 3-62
 Specifications — Page 3-65
 Dimensions — Page 3-68

Smart Motor Controllers

SMC Dialog Plus™ Smart Motor Controller

Product Selection, Continued

IP54 (Type 12) Enclosed Combination Controllers with Circuit Breaker – include a 120V control transformer and line and load terminations. The 97 to 1000A controllers include a bypass contactor and a Bulletin 825 converter module. Enclosures other than those listed are available; consult your nearest Allen-Bradley sales office.

HP Range	Controller Current Rating (A) ①	Price Adder Code	Cat. No. ②	*	HP Range	Controller Current Rating (A) ①	Price Adder Code	Cat. No. ②	*
208V AC, 60 Hz					240V AC, 60 Hz				
1-5	24	a	153H-B24JHD- ③		1-7-1/2	24	a	153H-B24JAD- ③	
7-1/2-10	35	b	153H-B35JHD- ③		10	35	b	153H-B35JAD- ③	
15-20	54	c	153H-B54JHD- ③		15-20	54	c	153H-B54JAD- ③	
25-30	97	d	153H-B97JHD- ③		25-30	97	d	153H-B97JAD- ③	
40	135	e	153H-B135JHD- ③		40-50	135	e	153H-B135JAD- ③	
50-60	180	f	153H-B180JHD- ③		60	180	f	153H-B180JAD- ③	
75	240	g	153H-B240JHD- ③		75	240	g	153H-B240JAD- ③	
100-125	360	h	153H-B360JHD- ③		100-150	360	h	153H-B360JAD- ③	
150	500	i	153H-B500JHD- ③		200	500	i	153H-B500JAD- ③	
200	650	j	153H-B650JHD- ③		250	650	j	153H-B650JAD- ③	
250	720	k	153H-B720JHD- ③		300	720	k	153H-B720JAD- ③	
300	850	l	153H-B850JHD- ③		350	850	l	153H-B850JAD- ③	
350	1000	m	153H-B1000JHD- ③		400	1000	m	153H-B1000JAD- ③	

HP Range	Controller Current Rating (A) ①	Price Adder Code	Cat. No. ②	*	HP Range	Controller Current Rating (A) ①	Price Adder Code	Cat. No. ②	*
480V AC, 60 Hz					600V AC, 60 Hz				
1-15	24	a	153H-B24JBD- ③		1-20	24	a	153H-B24JCD- ③	
20-25	35	b	153H-B35JBD- ③		25-30	35	b	153H-B35JCD- ③	
30-40	54	c	153H-B54JBD- ③		40-50	54	c	153H-B54JCD- ③	
50-75	97	d	153H-B97JBD- ③		60-75	97	d	153H-B97JCD- ③	
100	135	e	153H-B135JBD- ③		100-125	135	e	153H-B135JCD- ③	
125-150	180	f	153H-B180JBD- ③		150	180	f	153H-B150JCD- ③	
200	240	g	153H-B240JBD- ③		200-250	240	g	153H-B240JCD- ③	
250-300	360	h	153H-B360JBD- ③		300	360	h	153H-B360JCD- ③	
350-400	500	i	153H-B500JBD- ③		350-500	500	i	153H-B500JCD- ③	
450-500	650	j	153H-B650JBD- ③		600	650	j	153H-B650JCD- ③	
600	720	k	153H-B720JBD- ③		700	720	k	153H-B720JCD- ③	
700	850	l	153H-B850JBD- ③		800	850	l	153H-B850JCD- ③	
800	1000	m	153H-B1000JBD- ③		1000	1000	m	153H-B1000JCD- ③	

① The nominal current rating for the combination package may differ from the controller, based on the horsepower. Consult your nearest Allen-Bradley sales office.

② The catalog numbers listed are not complete. Select the horsepower suffix from Table 1 to complete the catalog number. Example: To order a circuit breaker style combination controller for a 200 HP motor with 240V line voltage, the catalog number is 153H-B240JAD-54.

③ Supplied without bypass contactor or converter module.

Table 1

HP	Suffix	HP	Suffix	HP	Suffix	HP	Suffix	HP	Suffix
1-5	-39	25	-44	75	-49	250	-56	500	-61
7.5	-40	30	-45	100	-50	300	-57	600	-62
10	-41	40	-46	125	-51	350	-58	700	-63
15	-42	50	-47	150	-52	400	-59	800	-65
20	-43	60	-48	200	-54	450	-60	1000	-67

Options — Page 3-59
 Accessories — Page 3-62
 Specifications — Page 3-65
 Dimensions — Page 3-68

Options

Option	Description	Price Adder Code	Cat. No. Modification	*
Soft Stop	Provides a ramp down time of 0–60 seconds for applications which require an extended coast-to-rest.	a–m	A ❶	
Pump Control	Provides smooth motor acceleration and deceleration, reducing surges caused by the starting and stopping of centrifugal pumps. Starting time is adjustable from 0 to 30 seconds, and stopping time is adjustable from 0 to 120 seconds.	a–m	B ❶	
Preset Slow Speed	Provides preset slow speeds for positioning or alignment applications. Preset speeds can be selected at either 7% or 15% of rated motor speed, with adjustable slow speed current from 0% to 450% of full load motor current.	a–m	C ❶	
SMB™ Smart Motor Braking	Provides a microprocessor based braking system that applies three-phase braking current to a standard squirrel cage induction motor. The strength of the braking current is adjustable from 0% to 400% of the motor's full load current rating.	a b c d e f g h i j k l m	D ❶	
Accu-Stop™	Provides stopping control for general positioning or to minimize jogging to stop. A three-phase braking current is applied to the motor (adjustable from 0% to 400% of full load current) until it reaches a preset slow speed (either 7% or 15% of rated motor speed). The motor is held at this speed until a stop command is given. Braking torque is then applied until the motor reaches zero speed. Slow speed current is adjustable from 0% to 450% of full load current.	a b c d e f g h i j k l m	E ❶	
Slow Speed with Braking	Provides a preset slow speed for positioning or alignment applications. Preset speeds can be selected at either 7% or 15% of rated motor speed, with adjustable slow speed current from 0% to 450% of full load current. Provides a microprocessor based braking system that applies three-phase braking current to a standard squirrel cage induction motor. The strength of the braking current is adjustable from 0% to 400% of full load motor current.	a b c d e f g h i j k l m	F ❶	
Protective Modules	24–54A, 480V Line Side Protective Module	a–c	-8L	
	97–360A, 480V Line Side Protective Module	d–h		
	24–54A, 600V Line Side Protective Module	a–c		
	97–360A, 600V Line Side Protective Module	d–h		
	24–54A, 480V Load Side Protective Module	a–c	-8M	
	97–360A, 480V Load Side Protective Module	d–h		
	24–54A, 600V Load Side Protective Module	a–c		
	97–360A, 600V Load Side Protective Module	d–h		
	24–54A, 480V Both Line and Load Side Protective Modules	a–c	-8B	
	97–360A, 480V Both Line and Load Side Protective Modules	d–h		
	24–54A, 600V Both Line and Load Side Protective Modules	a–c		
	97–360A, 600V Both Line and Load Side Protective Modules	d–h		

❶ Add the designated letter to the end of the Cat. No. For example, to add the Pump Control option: Cat. No. 150-B24NBDB or Cat. No. 152H-B180JBDB-51.

Product Selection — Page [3-51](#)

Smart Motor Controllers

SMC Dialog Plus™ Smart Motor Controller

Enclosed Options

Option	Description	Price Adder Code	Cat. No. Modification	*
Push Buttons	Start-Stop Push Button	a-m	-1	
	Start-Stop Push Button with H-O-A Selector Switch	a-m	-1F	
	Soft Stop Push Button ❶	a-m	-1XA ❶	
	Pump Stop Push Button ❶	a-m	-1XB ❶	
	Slow Speed Push Button ❶	a-m	-1XC ❶	
	Brake Push Button ❶	a-m	-1XD ❶	
	Accu-Stop/Slow Speed Push Button ❶	a-m	-1XE ❶	
Isolation Contactor	Line-Side Contactor	a-d e-f g h i j k-l m	❷	
Selector Switch	Hand-Off-Auto Selector Switch	a-m	-3	
Pilot Lights	Transformer Pilot Lights	a-m	-4_❸	
	Push-to-Test Pilot Lights	a-m	-5_❸	
Control Circuit Transformer	Control Circuit Transformer (fused primary and secondary)	a-m	-6P	
SCR Fusing	Fast acting current limiting SCR fusing for 24A unit	a	-SCR	
	Fast acting current limiting SCR fusing for 35A unit	b		
	Fast acting current limiting SCR fusing for 54A unit	c		
	Fast acting current limiting SCR fusing for 97-135A units	d-e		
	Fast acting current limiting SCR fusing for 180A unit	f		
	Fast acting current limiting SCR fusing for 240A unit	g		
	Fast acting current limiting SCR fusing for 360A unit	h		
	Fast acting current limiting SCR fusing for 500A unit	i		
	Fast acting current limiting SCR fusing for 650-720A units	j-k		
	Fast acting current limiting SCR fusing for 850A unit	l		
	Fast acting current limiting SCR fusing for 1000A unit	m		
Door-Mounted Human Interface Module	Programmer Only (Type 1)	a-m	-HAP	
	Programmer Only (Type 4/12)	a-m	-HJP	
	Digital Control Panel (Type 1)	a-m	-HA2	
	Digital Control Panel (Type 4/12)	a-m	-HJ2	
Communication Module	Remote I/O	a-m	-GD1	
	RS-232/422/485	a-m	-GD2	
	DH485	a-m	-GD2	
	DeviceNet™ Network	a-m	-GK5	
Unwired Control Relays	Bulletin 700F 4-pole relay - 2 N.O. and 2 N.C.	a-m	-89F22	
	Bulletin 700F 4-pole relay - 3 N.O. and 1 N.C.	a-m	-89F31	
	Bulletin 700F 4-pole relay - 4 N.O.	a-m	-89F40	

❶ Option pushbuttons are available only when the corresponding option module is selected. For example: **Cat. No. 150-B24JBDA-1XA**.

❷ To order a combination enclosed controller with an isolation contactor, add the letter **B** to the bulletin prefix. For example, **Cat. No. 152H-B135JBD-50** becomes **Cat. No. 152B-B135JBD-50**. Bulletin 100 contactors are used through 600A. Enclosure dimensions are subject to change. Consult your nearest Allen-Bradley sales office.

❸ Specify pilot light lens color. Options: **Amber, Blue, Clear, Green, Red, and White**. For example, **-4R** for a red lens.

Enclosed Options, Continued

Option	Description	Price Adder Code	Cat. No. Modification	*
Auxiliary Contacts	N.O. auxiliary contacts for 24–240A units	a–g	-90	
	N.O. auxiliary contacts for 360–1000A units	h–m		
	N.C. auxiliary contacts for 24–240A units	a–g	-91	
	N.C. auxiliary contacts for 360–1000A units	h–m		
Disconnect Auxiliary	N.O. disconnect auxiliary mounted on operating mechanism (operates with movement of external handle only)	a–m	-98	
	N.C. disconnect auxiliary mounted on operating mechanism (operates with movement of external handle only)	a–m	-99	
Circuit Breaker Auxiliary	Internal N.O. circuit breaker auxiliary	a–m	-98X	
	Internal N.C. circuit breaker auxiliary	a–m	-99X	
Shunt Trip	Circuit Breaker Shunt Trip for 24–54A units	a–c	-754	
	Circuit Breaker Shunt Trip for 97–135A units	d–e		
	Circuit Breaker Shunt Trip for 180–240A units	f–g		
	Circuit Breaker Shunt Trip for 360–500A units	h–i		
	Circuit Breaker Shunt Trip for 650–850A units	j–l		
	Circuit Breaker Shunt Trip for 1000A unit	m		
Line Voltage Monitor	Bulletin 813S Line Voltage Monitor	a–m	-813S	
Window Kit	Standard (3"H x 5"W)	a–m	-WK1	
	Hinged (10"H x 10"W)	a–m	-WK2	

Smart Motor Controllers

SMC Dialog Plus™ Smart Motor Controller

Accessories – Field Installed

Protective Modules ①②

	Current Rating	Description	Price Adder Code	Field Modification Cat. No.	*
	24-54A	480V Protective Module	a-c	150-N84	
		600V Protective Module		150-N86	
	97-360A	480V Protective Module	d-h	150-N84L	
600V Protective Module		150-N86L			

- ① The same protective module mounts on the line or load side of the SMC Dialog Plus Controller. For applications requiring both line and load side protection, two protective modules must be ordered.
- ② Surge protection is provided as standard on 500A through 1000A units.



Terminal Lug Kits (97A through 1000A) ③



	Current Rating	Conductor Range	Total No. of Terminal Lugs Possible Each Side		Pkg. Qty.	Cat. No.	*
			Line Side	Load Side			
	97-135A	#6-4/0 AWG	3	3	3	199-LF1	
	180-360A	#6-4/0 AWG	6	6	3	199-LF1	
	500A	#4-500MCM AWG	6	6	3	199-LG1	
	650-720A	#4-500MCM AWG	9	9	3	199-LG1	
850-1000A	(2) 1/0-500MCM AWG	6	6	3	199-LJ1		

IEC Terminal Covers.

	Description	Field Modification Cat. No.	*
	IEC line or load terminal covers for 97-135A devices (includes line and load termination covers)	150-NT1	
	IEC line and load terminal covers for 180-360A devices (includes line and load termination covers)	150-NT2	

Accessories – Field Installed, Continued

Description			Cat. No.	*	
 <p><i>Cat. No. 1201-HAP</i></p>  <p><i>Cat. No. 1201-HA1</i></p>  <p><i>Cat. No. 1201-HA2</i></p>	Human Interface Modules	Door Mount Bezel Kit	IP30 Type 1	1201-DMA	
		Programmer Only	IP30 Type 1	1201-HAP	
			IP65 Type 4/12	1201-HJP	
		Analog Control Panel ❶	IP30 Type 1	1201-HA1	
		Digital Control Panel ❶	IP30 Type 1	1201-HA2	
			IP65 Type 4/12	1201-HJ2	

Description			Use With	Type 1 (IP30) Cat. No.	*	
 <p><i>Communication Cable Cat. No. 1202-C10</i></p>	Communication Cables	Male-Male	Human Interface Module and Communications Modules	1/3 Meter	1202-C03	
				1 Meter	1202-C10	
				3 Meters	1202-C30	
				9 Meters	1202-C90	
 <p><i>Communication Module Cat. No. 1203-GD1</i></p>	Communication Modules	Single Point Remote I/O ❷		1203-GD1		
		RS232/RS422/RS485/DF1 ❷		Bulletin 150 SMC Dialog Plus	1203-GD2	
		DH485 ❷			1203-GD2	
		DeviceNet Network			1203-GK5	
DriveTools™	Programming Software ❸		Personal Computer	1300-DTLS		



- ❶ Start, Stop, and Jog buttons are the only active controls when used with the SMC Dialog Plus controller.
- ❷ Separately powered 120/240V AC.
- ❸ Requires the use of a 1203-GD2 communication module.
- ❹ Consult your nearest Allen-Bradley sales office.



Smart Motor Controllers

SMC Dialog Plus™ Smart Motor Controller

Accessories – Field Installed, Continued

Converter Modules ❶

Description	Motor Full Load Current Range (A)	Cat. No.	*
 <p><i>Cat. No. 825-MCM20</i></p>	1 - 12.5	825-MCM20	
 <p><i>Cat. No. 825-MCM180</i></p>	9 - 100	825-MCM180	
 <p><i>Cat. No. 825-MCM630</i></p>	64 - 360	825-MCM630	

Description	Cat. No.	*
Fanning Strip for Bulletin 825 Converter Modules  <p><i>Cat. No. 150-NFS</i></p>	150-NFS	
Optional Bus Bars for Cat. No. 825-MCM180 Features Terminals: M8 4 x 16 x 102mm Weight: 230g 	825-MVM	

❶ Must be used with fanning strip **Cat. No. 150-NFS**.

❷ Use **Discount Schedule O7**.

Specifications

Functional Design Specifications

Standard Features	Installation	Power Wiring	The SMC Dialog Plus controller can be wired with or without an isolation contactor. Bypass contactors can be employed after the controller has brought the motor to full speed.
		Control Wiring	2- and 3-wire control for a wide variety of applications.
	Set-up	Keypad	The SMC Dialog Plus controller is configured with the front keypad and backlit LCD display.
		Software	Parameter values can be downloaded to the SMC Dialog Plus controller with DriveTools programming software and the 1203-GD2 communication module.
	Communications		One serial port provided for connection to optional human interface and communication modules.
	Starting Modes		Soft start with selectable kickstart, current limit, dual ramp, and full voltage in one unit.
	Protection and Diagnostics		Power loss, line fault, voltage unbalance, excessive start/dhour, phase reversal, undervoltage, overvoltage, controller temp, stall, jam, open gate, overload, underload, communication fault.
	Metering		Amps, volts, kW, kWh, elapsed time, power factor, motor thermal capacity usage.
	Status Indication		Stopped, ramping, stopping, at speed, and fault.
	Auxiliary Contacts		2 form "C" programmable as normal or up-to-speed; one programmable as normal or fault.
Optional Features	Soft Stop		Extended coast-to-rest to minimize load shifting. Ramp down time is adjustable from 0 to 60 seconds.
	Pump Control		Reduces fluid surges in centrifugal pumping systems during starting and stopping period. Starting time is adjustable from 0 to 30 seconds. Stopping time is adjustable from 0 to 120 seconds.
	Preset Slow Speed		Enables the operator to position material. The preset slow speed can be set for low (7% of base speed), high (15% of base speed), reverse low (10% of base speed) or reverse high (20% of base speed).
	SMB Smart Motor Braking		Provides motor braking without additional equipment for applications that require the motor to stop quickly. Braking current is adjustable from 0% to 400% of the motor's full load current rating.
	Accu-Stop/Slow Speed with Braking		Combines Smart Motor Braking and Preset Slow Speed. Braking current is adjustable from 0% to 400% of full load current. Slow speed can be set for either Low (7% of base speed) or High (15% of base speed).

Smart Motor Controllers

SMC Dialog Plus™ Smart Motor Controller

Specifications, Continued

Electrical Ratings		UL / CSA / NEMA	IEC
Power Circuit:	Rated Operation Voltage	200–480V AC 200–600V AC (–15%, +10%)	200–415V ~ 200–500V ~
	Rated Insulation Voltage	N/A	500V ~
	Rated Impulse Voltage	N/A	6000V
	Dielectric Withstand	2200V AC	2500V ~
	Repetitive Peak Inverse Voltage Rating	200–480V AC: 1400V 200–600V AC: 1600V	200–415V ~: 1400V 200–500V ~: 1600V
	Operating Frequency	50/60 Hz	50/60 Hz
	Utilization Category	MG 1	AC-53a
	Protection Against Electrical Shock	N/A	IP00 (open device)
	DV/DT Protection	RC Snubber Network	
	Transient Protection	Metal Oxide Varistors: 220 Joules @ 24–360A 220 Joules @ 480V, 500–1000A 300 Joules @ 600V, 500–1000A	
Short Circuit Protection:	SCPD Performance	Type 1	
	SCPD List	Maximum Fuse or Circuit Breaker:	
	Device Operational Current Rating:	24A 35A 54A 97A 135A 180A 240A 360A 500A 650A 720A 850A 1000A	80A 125A 200A 350A 500A 600A 700A 1000A 1200A 1600A 2000A 2500A 3000A
Control Circuit:	Rated Operational Voltage	100–240V AC 24V AC 24V DC	100–240V ~ 24V ~ 24V DC
	Rated Insulation Voltage	N/A	240V ~
	Rated Impulse Voltage	N/A	3000V
	Dielectric Withstand	1600V AC	2000V ~
	Operating Frequency	50/60 Hz	50/60 Hz
	Protection Against Electric Shock	N/A	IP20
Power Requirements:	Control Module	40 VA	
	Heatsink Fan(s)❶	24A 35A 54A 97A 135A 180A 240A 360A 500A 650A 720A 850A 1000A	– – – 45 VA 45 VA 45 VA 45 VA 45 VA 145 VA 320 VA 320 VA 320 VA 320 VA

❶ For devices rated 24–500A, heatsink fans can be powered by either 110/120V AC or 220/240V AC. For devices rated 650–1000A, heatsink fans can only be powered by 110/120V AC.

Specifications, Continued

Electrical Ratings, Continued		UL / CSA / NEMA	IEC
Maximum Heat Dissipation (Watts):	Controller Rating:		
	24A		110
	35A		150
	54A		200
	97A		285
	135A		490
	180A		660
	240A		935
	360A		1170
	500A		1400
	650A		2025
	720A		2250
	850A		2400
	1000A		2760
Auxiliary Contacts:	Rated Operation Voltage	240V AC	240V ~
	Rated Insulation Voltage	N/A	240V ~
	Dielectric Withstand	1600V AC	2000V ~
	Operating Frequency	50/60 Hz	50/60 Hz
	Utilization Category	B300 (terminals 18–19) C300 (terminals 18–20) C300 (terminals 29–30)	AC-15
	SCPD Performance	Type 2	
	SCPD List	Class CC 8A @ 1000A Available Fault Current	
Environmental			
Operating Temperature Range		0°C – 50°C (32°F – 122°F) (open) 0°C – 40°C (32°F – 104°F) (enclosed)	
Storage and Transportation Temperature Range		–20°C – +75°C	
Altitude		2000 meters	
Humidity		5% – 95% (non-condensing)	
Pollution Degree		2	
Mechanical			
Resistance to Vibration		1.0 G Peak, 0.006 Inch Displacement 2.5 G, 0.015 Inch Displacement	
	Operational Non-Operational		
Resistance to Shock		15 G 30 G	
	Operational Non-Operational		
Construction		Power Poles: Thermoset Moldings: 24–135A Heatsink hockey puck thyristor: 180–1000A Control Modules: Thermoset and Thermoplastic Moldings Metal Parts: Anodized Aluminum, Plated Brass, Copper or Painted Steel	
Terminals		Power Terminals: 24–54A: 6.0mm hole with clamp screw 97 & 135A: One 11.5mm (.453) diameter hole each 180–360A: One 10.5mm (.413) diameter hole each 500A: Two 13.5mm (.531) diameter holes each 650 & 720A: Three 13.1mm (.515) diameter holes each 850 & 1000A: Six 13.1mm (.515) diameter holes each Power Terminal Markings: NEMA, CENELEC EN50 012 Control Terminals: M 3.5 x 0.6 Pozidriv screw with self-lifting clamp plate	

Smart Motor Controllers**SMC Dialog Plus™ Smart Motor Controller****Specifications, Continued**

Other		
EMC Emission Levels	Conducted Radio Frequency Emissions Radiated Emissions	Class A Class A
EMC Immunity Levels	Electrostatic Discharge Radio Frequency Electromagnetic Field Fast Transient Surge Transient	8 kV Air Discharge Per IEC 947-4-2 Per IEC 947-4-2 Per IEC 947-4-2
Overload Characteristics	Current Range Trip Classes Trip Current Rating Number of Poles	1.0-999.9 Amps 10, 15, 20 & 30 120% of Motor FLC 3

Approximate Dimensions and Shipping Weights**Open Type Controllers**

Dimensions are not intended for manufacturing purposes.

Controller	Dimensions in Millimeters (Inches)			
	Height	Width	Depth	Weight
24A	180 (7.09)	154 (6.06)	185 (7.29)	4.5 kg 10 lbs.
35A	240 (9.45)	214 (8.43)	195 (7.68)	6.8 kg 15 lbs.
54A	290 (11.42)	244 (9.61)	225 (8.86)	11.3 kg 25 lbs.
97A	336 (13.23)	248 (9.77)	256 (10.09)	10.4 kg 23 lbs.
135A	336 (13.23)	248 (9.77)	256 (10.09)	11.8 kg 26 lbs.
180A	560 (22.06)	273 (10.75)	294 (11.58)	25 kg 55 lbs.
240A	560 (22.06)	273 (10.75)	294 (11.58)	30 kg 65 lbs.
360A	560 (22.06)	273 (10.75)	294 (11.58)	30 kg 65 lbs.
500A	588 (23.17)	508 (20.00)	311 (12.23)	40.8 kg 90 lbs.
650A-1000A	1524 (60.0)	813 (32.00)	402 (15.83)	167.8 kg 370 lbs.

Approximate Dimensions and Shipping Weights, Continued

Enclosed Type Controllers

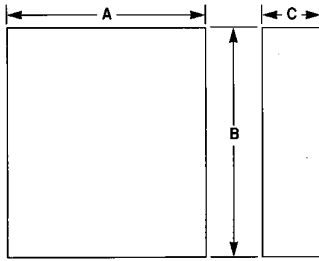

Dimensions are in millimeters (inches). Dimensions are not intended for manufacturing purposes. All dimensions are subject to change.

Factory installed options may affect enclosure size requirements.

Exact dimensions can be obtained after order entry. Please consult your nearest Allen-Bradley sales office.

Controller Rating	IP30 (Type 1)			IP54 (Type 12)			IP65 (Type 4)		
	B Height	A Width	C Depth	B Height	A Width	C Depth	B Height	A Width	C Depth
Non-Combination Controller									
24A	610 (24)	406 (16)	229 (9)	610 (24)	406 (16)	229 (9)	610 (24)	406 (16)	229 (9)
35A	762 (30)	610 (24)	305 (12)	762 (30)	610 (24)	305 (12)	762 (30)	610 (24)	305 (12)
54A	762 (30)	610 (24)	305 (12)	762 (30)	610 (24)	305 (12)	762 (30)	610 (24)	305 (12)
97A	762 (30)	610 (24)	305 (12)	762 (30)	610 (24)	305 (12)	762 (30)	610 (24)	305 (12)
135A	965 (38)	762 (30)	356 (14)	965 (38)	762 (30)	356 (14)	965 (38)	762 (30)	356 (14)
180A	965 (38)	762 (30)	356 (14)	965 (38)	762 (30)	356 (14)	965 (38)	762 (30)	356 (14)
240A	965 (38)	762 (30)	356 (14)	1295 (51)	914 (36)	356 (14)	1295 (51)	914 (36)	356 (14)
360A	1295 (51)	914 (36)	356 (14)	1295 (51)	914 (36)	356 (14)	1295 (51)	914 (36)	356 (14)
500A	2286 (90)	635 (25)	508 (20)	1829 (72)	940 (37)	610 (24)	2286 (90)	889 (35)	508 (20)
650A	2286 (90)	889 (35)	508 (20)	1880 (74)	1829 (72)	610 (24)	2286 (90)	1778 (70)	508 (20)
720A	2286 (90)	889 (35)	508 (20)	1880 (74)	1829 (72)	610 (24)	2286 (90)	1778 (70)	508 (20)
850A	2286 (90)	889 (35)	508 (20)	⓪	⓪	⓪	⓪	⓪	⓪
1000A	2286 (90)	889 (35)	508 (20)	⓪	⓪	⓪	⓪	⓪	⓪
Combination Controllers with Fusible Disconnect									
24A	762 (30)	610 (24)	305 (12)	762 (30)	610 (24)	305 (12)	-	-	-
35A	762 (30)	610 (24)	305 (12)	762 (30)	610 (24)	305 (12)	-	-	-
54A (6A Disconnect)	762 (30)	610 (24)	305 (12)	762 (30)	610 (24)	305 (12)	-	-	-
54A (100A Disconnect)	965 (38)	762 (30)	356 (14)	965 (38)	762 (30)	356 (14)	-	-	-
97A	965 (38)	762 (30)	356 (14)	965 (38)	762 (30)	356 (14)	-	-	-
135A	965 (38)	762 (30)	356 (14)	965 (38)	762 (30)	356 (14)	-	-	-
180A	1295 (51)	914 (36)	356 (14)	1295 (51)	914 (36)	356 (14)	-	-	-
240A	1295 (51)	914 (36)	356 (14)	1295 (51)	914 (36)	356 (14)	-	-	-
360A	1524 (60)	914 (36)	356 (14)	1524 (60)	914 (36)	356 (14)	-	-	-
500A	2286 (90)	1143 (45)	508 (20)	2286 (90)	1270 (50)	508 (20)	-	-	-
650A	2286 (90)	1397 (55)	508 (20)	2286 (90)	1778 (70)	508 (20)	-	-	-
720A	2286 (90)	1397 (55)	508 (20)	2286 (90)	1778 (70)	508 (20)	-	-	-
850A	⓪	⓪	⓪	⓪	⓪	⓪	-	-	-
1000A	⓪	⓪	⓪	⓪	⓪	⓪	-	-	-
Combination Controllers with Circuit Breaker									
24A	762 (30)	610 (24)	305 (12)	762 (30)	610 (24)	305 (12)	-	-	-
35A	762 (30)	610 (24)	305 (12)	762 (30)	610 (24)	305 (12)	-	-	-
54A	762 (30)	610 (24)	305 (12)	762 (30)	610 (24)	305 (12)	-	-	-
97A	965 (38)	762 (30)	356 (14)	965 (38)	762 (30)	356 (14)	-	-	-
135A	965 (38)	762 (30)	356 (14)	965 (38)	762 (30)	356 (14)	-	-	-
180A	1295 (51)	914 (36)	356 (14)	1295 (51)	914 (36)	356 (14)	-	-	-
240A	1295 (51)	914 (36)	356 (14)	1295 (51)	914 (36)	356 (14)	-	-	-
360A	1524 (60)	914 (36)	356 (14)	1524 (60)	914 (36)	356 (14)	-	-	-
500A	2286 (90)	889 (35)	508 (20)	2286 (90)	889 (35)	508 (20)	-	-	-
650A	2286 (90)	1397 (55)	508 (20)	2286 (90)	1778 (70)	508 (20)	-	-	-
720A	2286 (90)	1397 (55)	508 (20)	2286 (90)	1778 (70)	508 (20)	-	-	-
850A	⓪	⓪	⓪	⓪	⓪	⓪	-	-	-
1000A	⓪	⓪	⓪	⓪	⓪	⓪	-	-	-

⓪ Consult your nearest/local Allen-Bradley sales office.

Smart Motor Controllers**SMC Dialog Plus™ Smart Motor Controller****Related Publications**

Publication Number	Title	Description
150-2.5 ❶	Feature Summary	This document assists specifiers in creating a complete solid-state reduced voltage starter specification.
150-2.6	Starting Solutions: Solid-State Controllers vs. Electromechanical Starters	This document looks at: <ul style="list-style-type: none"> • the history of AC motor starter technology • the selection of the various starting methods • the key issues involving trade-offs of the various starting methods
150-5.2	Application and Product Guide	This publication provides detailed information on; <ul style="list-style-type: none"> • standard modes of operation • product features • control options • examples of typical applications • special application considerations
150-911	A Unique Cost-Effective Approach to Reducing Fluid “Surges” or “Hammering” in a Pipe System	This document provides a technical discussion of centrifugal pumping systems. The Pump Control option of the SMC Dialog Plus controller is featured as a cost-effective method to minimize the phenomenon known as “water hammer.”

❶ Available on computer disk; consult your nearest Allen-Bradley sales office.